

SAW FENCE KIT

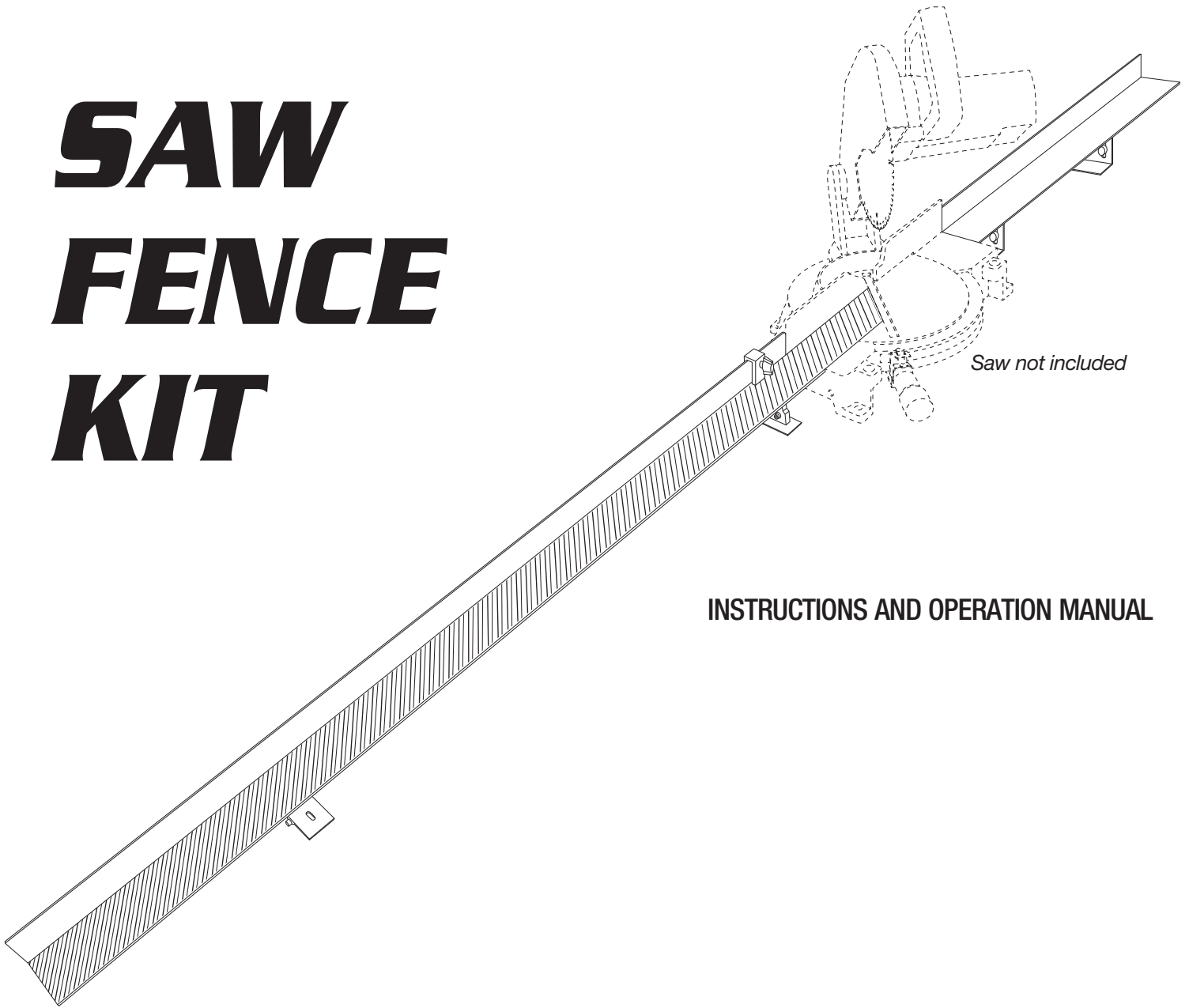

INSTRUCTIONS AND OPERATION MANUAL



LoganGraphic.com

Purchase Date

ID Number (on bottom of board)

Date (on bottom of board)

Tools Needed

- 36" – 48" Straight Edge or Level
- 9/64" Drill Bit
- Phillips Screwdriver
- 3/8" Open End Wrench
- Pencil
- Tape Measure
- Board – 1/2" x 12" x 80" MDF or Plywood Board (Optional)
- Plastic Clamp (Optional)
- Power Drill
- Utility Knife

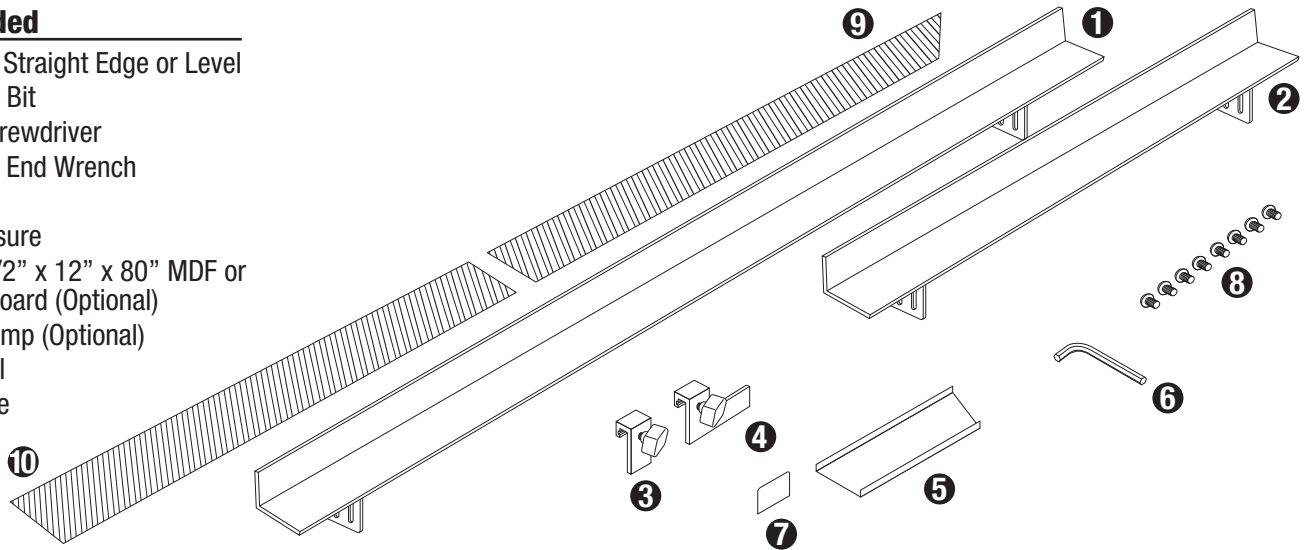

Parts List

1. 53" Left Fence
2. 27" Right Fence
3. Stop
4. Extension Stop
5. Scale Setting Gauge
6. Allen Wrench
7. Marking Label
8. Screws (8)
9. Scale A
10. Scale B

WARRANTY: Logan Graphic Products, Inc. ("Logan") warrants the F100-5 SAW FENCE KIT to be free from defects in parts and workmanship for a period of two years from the date of original purchase. Logan warrants that it will either repair or replace, in its sole discretion, any necessary replacement parts found to be defective. Should the product need to be returned to Logan for repair or replacement parts, authorization for any return must come from Logan in writing. Costs of returning the product to Logan, including insurances, shall be borne by the purchaser. Logan shall not be liable for any damages or losses, incidental or consequential, direct or indirect, arising from the use of this product. This warranty extends only to the original purchaser and is not assignable or transferable. This warranty is in lieu of all other warranties, expressed or implied. Be advised that any Logan products purchased as "new" from an unauthorized dealer, such as an online auction site or similar, may be void of their warranty. Logan Graphic Products, Inc., 1100 Brown Street, Wauconda, IL 60084 800-331-6232 847-526-5515

A. Set Fence Height

1. Align one end of fence with edge of saw base. (Fig. 1, Fig. 2)
2. Set height by holding down bracket and adjusting fence until even with base. (Fig. 3)
3. Align and set height of other end of fence. (Fig. 4)
4. Recheck first fence setting, adjust if necessary.
5. Tighten bracket screws with allen wrench. (Fig. 5)

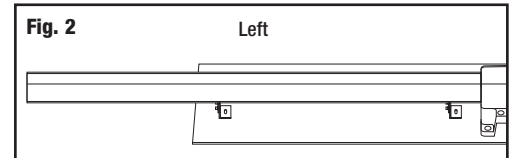
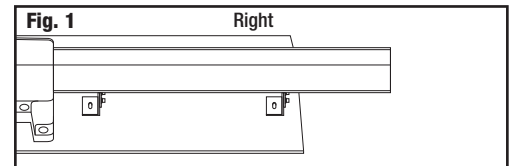

B. Mount Saw

1. Mount saw directly to table or a board.
2. If you are using a board, MDF or high quality plywood is recommended, 1/2" to 3/4" thick, cut to 12" x 80". (Fig. 6)
 - a. Mount the saw 28" from right end of board for fences to fit. (Fig. 7)

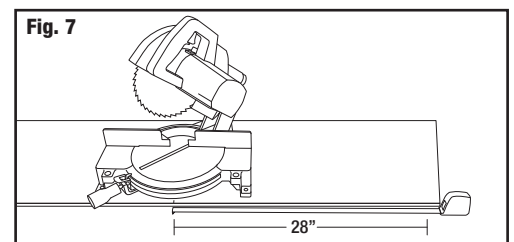
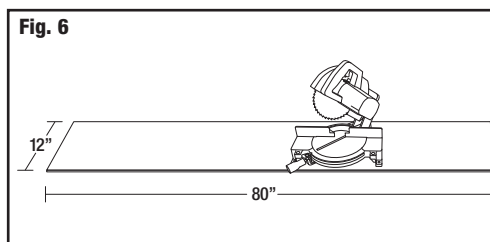
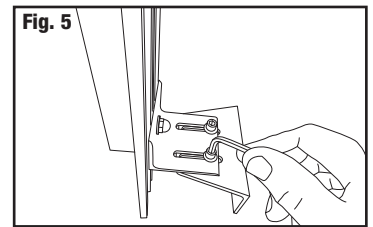
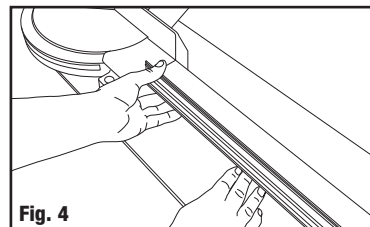
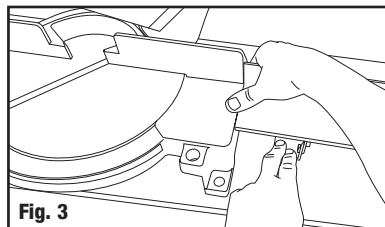

C. Mount Fences

1. The short fence is positioned to the right of the saw and the long fence is positioned to the left of the saw.
2. Using a straight edge, align fence with saw. (Fig. 8, 9)
3. Locate and mark holes in each bracket with a pencil. (Fig. 10)
4. Remove fence.
5. Drill a 9/64" (.140") hole in center of each marked hole.
6. Using straight edge, realign fence with saw.
7. Mount brackets using wood screws and phillips screwdriver. (Fig 11)

D. Apply the Scales

1. Unplug saw.
2. Set saw to 45° left side cut. (Fig. 12)
3. Lower saw blade.
4. Using scale gauge, slide up to teeth of the blade and against saw fence. (Fig. 13)
5. Apply marking label to fence back at scale gauge end. (Fig. 14)
6. Realign scale gauge against saw teeth and up against label. (Fig. 15)
7. Mark label with pencil at end of gauge. (Fig. 15)
8. Lift saw blade up.
9. Scale A has been pre-scored across the 6-inch area. Remove only this section in order to set it in the correct location. (Fig 16)
10. Align 6" increment of Scale A with marked line on label. Make sure rear edge of scale is directly against saw fence. (Fig. 17)
11. Now lift scale from left of 6" increment and carefully pull away the backing paper. Make sure the edge of the scale is up against the fence back. (Fig. 18)
12. Smooth down with pressure to set.
13. Remove prescored section on back of Scale B.
14. Align Scale B end exactly to Scale A end. (Fig. 19)
15. Remove backing paper.
16. Smooth down with pressure to set.
17. Using a utility knife, cut through the space between the saw bed and turntable. This allows turntable to rotate. (Fig. 20)

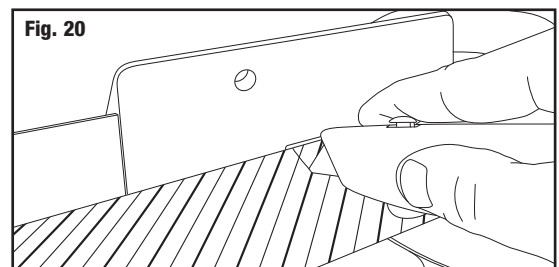
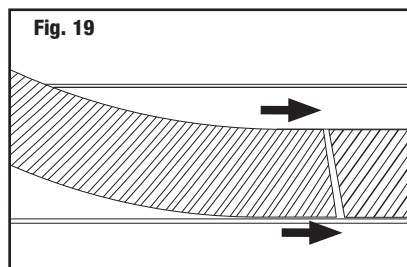
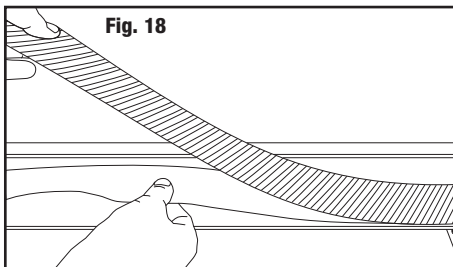
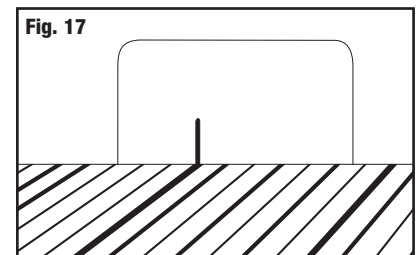
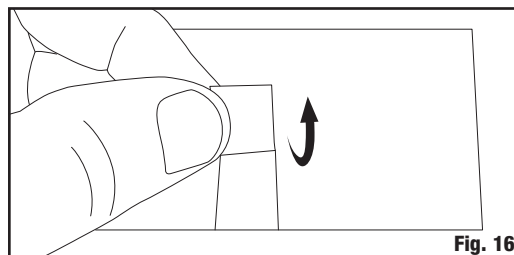
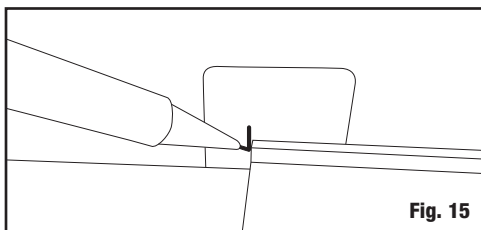
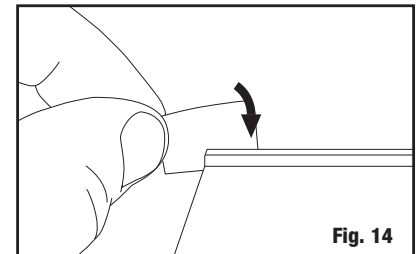
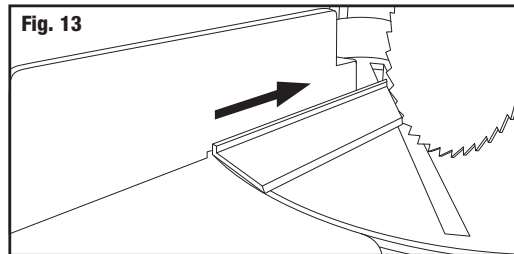
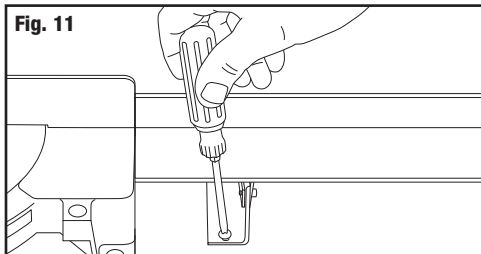
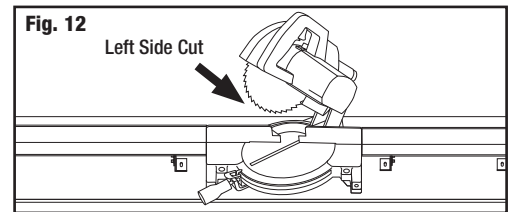
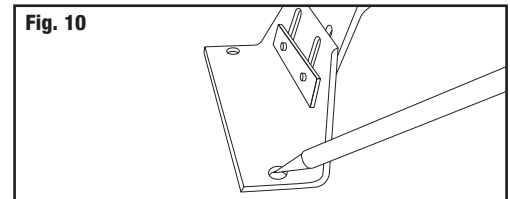
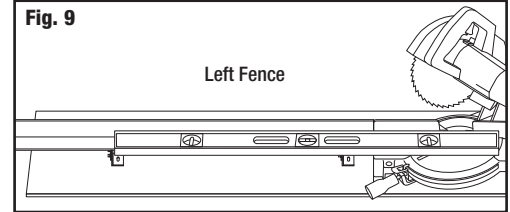
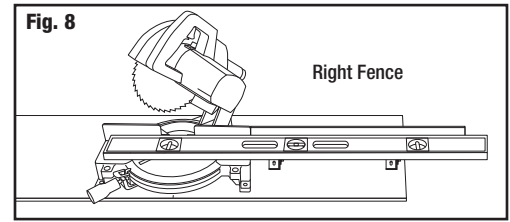

E. Measuring

1. There are two stops included. The long stop is used for any lengths shorter than the fence.
2. To attach stops, loosen screw enough to drop onto fence and tighten screw to secure. (Fig. 20)
3. To set the stop, slide mitered edge of moulding to dimension needed. Align the bottom of the rabbet with the increment. (Fig 21)
4. Slide stop against moulding and tighten. (Fig. 22)

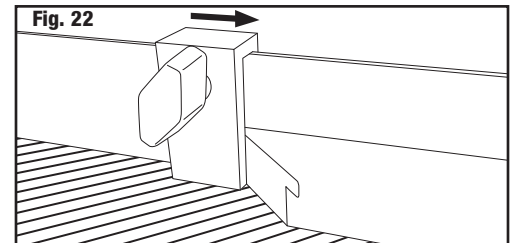
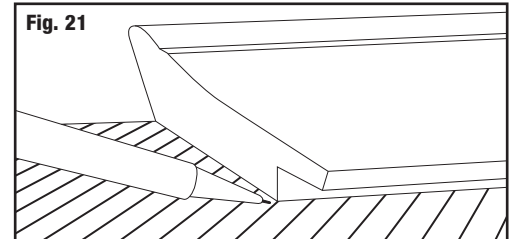
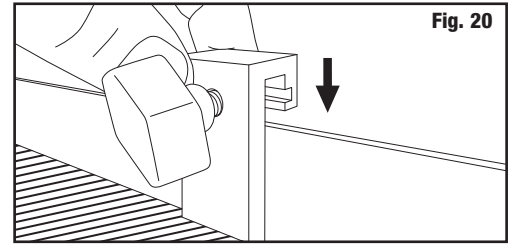

Hint - As a rule, always add 1/8" to moulding lengths to provide clearance for glass, artwork and backing materials to fit inside frame.

F. Cutting (2 Pieces – Same Length – One Side)

1. Set saw to 45° right cut.
2. Slide moulding against right fence with rabbet facing out, 1" past blade slot. (Fig. 23)
3. Cut.
4. Slide moulding onto left fence and to dimension. (Be sure to add 1/8" to dimension for materials clearance)
5. Set stop by holding moulding and adjusting stop against end. (Fig. 24)
6. Reset saw to left 45° cut. (Fig. 25)
7. Cut.
8. Reset saw to right 45° cut.
9. Slide moulding 1" past blade slot.
10. Cut.
11. Slide moulding down and up to stop.
12. Rest saw to left 45° cut.
13. Cut.

Hint - Cut 2 pieces at each saw setting to reduce saw resetting.

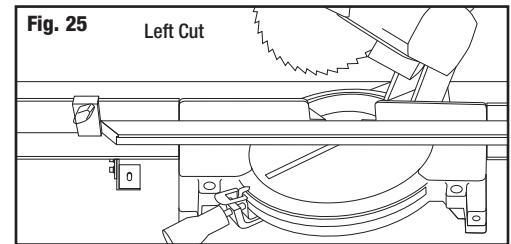
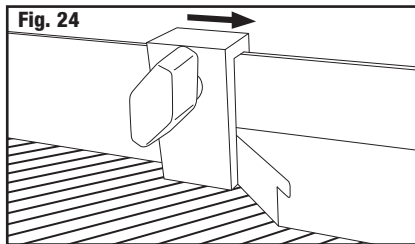
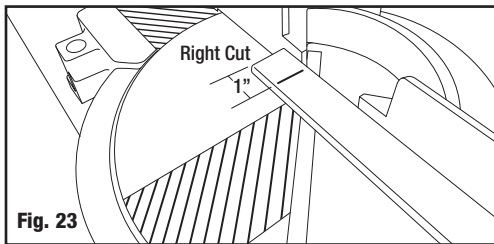

Helpful Hints

- Use plastic clamps for added security. (Fig. 26)
- Always cut longer side first so if a mistake is made, they may be used for shorter sides.
- Use 80 to 100 tooth saw blades for best results.
- Lower blade into material slowly for best results.
- Check cut lengths by laying them side by side on a hard, even surface; align one end and check the other. (Fig. 27) If not exactly even, use **Logan Elite Sander F200-2** to produce accurate size and precise 45° angles.

